

Axonometrie a pohledy 1

Řešení

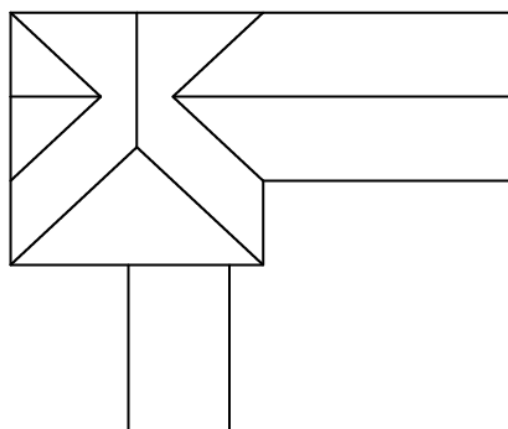
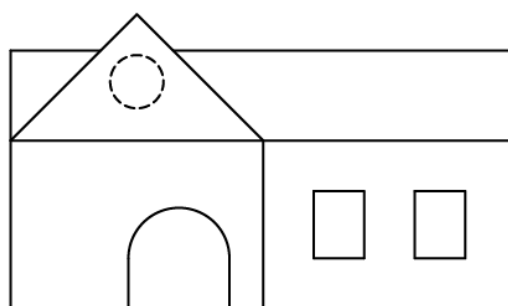
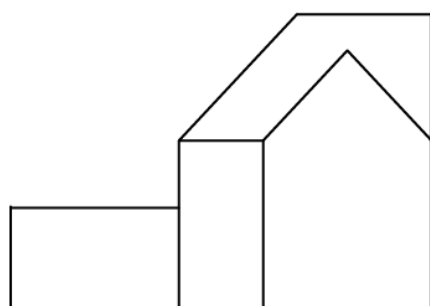
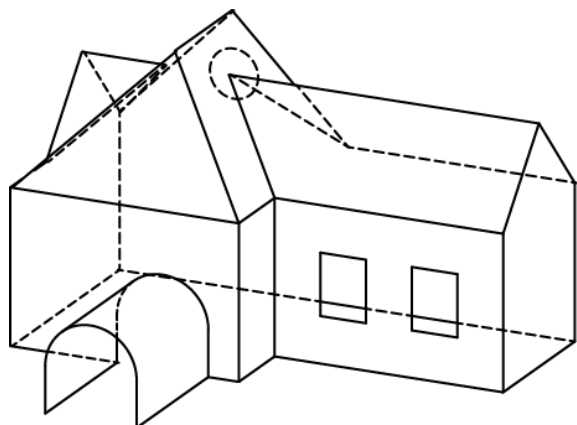

Axonometrie a pohledy 5

Řešení

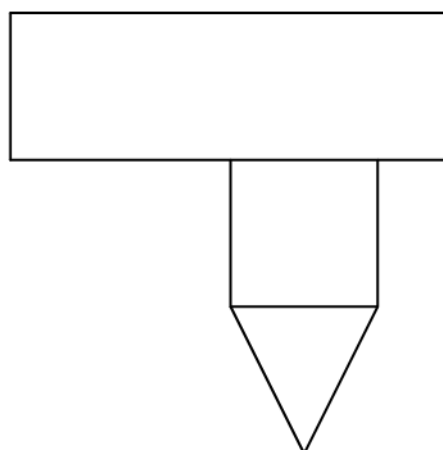
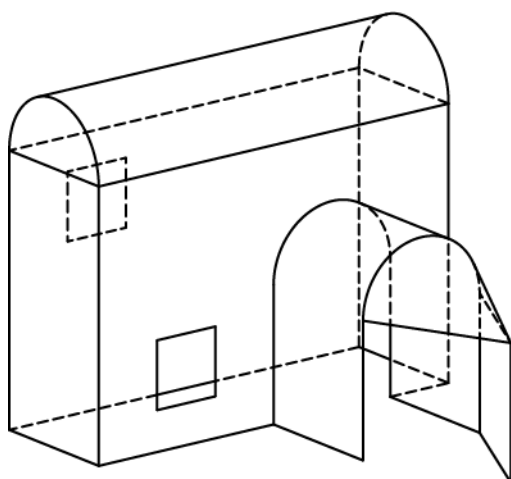
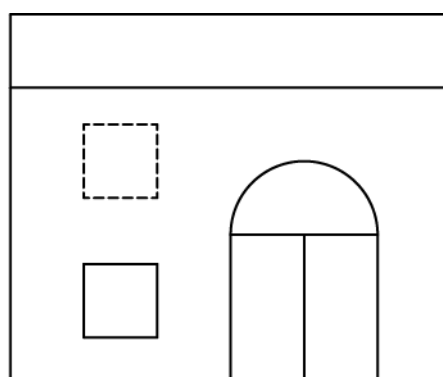
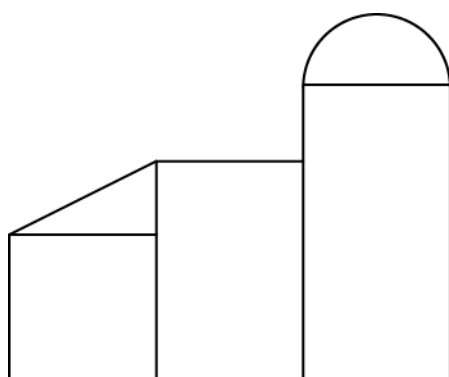

Kompletní řešení všech pracovních listů k tématu Axonometrie a pohledy jsou k dispozici u vyučujících předmětu Konstruktivní geometrie.